



ED-IPC2100

User Manual

by EDA Technology Co., Ltd

built: 2024-10-18

1 Hardware Manual

This chapter introduces the product overview, packing list, appearance, button, indicator and interface.

1.1 Overview

ED-IPC2100 series is a highly reliable industrial computer based on Raspberry Pi CM4. According to different application scenarios and user needs, different specifications of RAM and eMMC computer systems can be selected.

- RAM can choose 1GB、 2GB、 4GB and 8GB
- eMMC can choose 8GB、 16GB and 32GB

ED-IPC2100 series provides common interfaces such as HDMI, USB, Ethernet, RS232 and RS485, and supports access to the network through Wi-Fi, Ethernet and 4G. The integration of super capacitor (backup power supply, which is optional), RTC, Watch Dog, EEPROM and encryption chip provides the ease of use and reliability of the product, which is mainly used in industrial control and IOT.



1.2 Packing List

- 1x ED-IPC2100 Unit (with DIN-rail bracket)
- [optional Wi-Fi/BT version] 1x 2.4GHz/5GHz Wi-Fi/BT Antenna
- [optional 4G version] 1x 4G/LTE Antenna

1.3 Appearance

Introducing the functions and definitions of interfaces on each panel.

1.3.1 Front Panel

Introducing the front panel interface types and definitions.

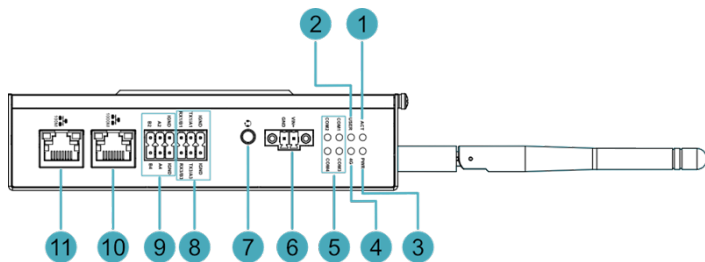

NO.	Function Definition
1	1 x green system status indicator, which is used to check the working status of device.
2	1 x green user indicator, user can customize a status according to actual application.
3	1 x red power indicator, which is used to check the status of device power-on and power-off.
4	1 x green 4G indicator, which is used to check the status of 4G signal.
5	4 x green UART indicators, which is used to check the communication status of UART port.
6	1 x DC input, 2-Pin 3.5mm spacing phoenix terminals with screw holes. It supports 9V~36V input, the signal is defined as VIN+/GND.
7	1 x Audio input/Stereo output, 3.5mm audio jack connector. It can be used as MIC IN and LINE OUT. <ul style="list-style-type: none"> • When a headphone is connected, the audio output is switched to the headphone. • When a headphone is not connected, the audio output is switched to the speaker. Note: Only ED-IPC2120 contains this interface.
8	2 x RS232/RS485 ports, 6-Pin 3.5mm spacing phoenix terminals, which is used to connect third-party control equipment. Different combinations of RS232 and RS485 can be selected according to actual needs, and there are three combinations: <ul style="list-style-type: none"> • ED-IPC2110: 2 x RS232 • ED-IPC2120: 2 x RS232 • ED-IPC2130: 1 x RS232 and 1 x RS485 • ED-IPC2140: 2 x RS485
9	2 x RS485 ports, 6-Pin 3.5mm spacing phoenix terminal, which is used to connect the third-party control equipment.
10	1 x 10/100/1000M adaptive ethernet port, RJ45 connector, with led indicator. It can be used to access the network.
11	1 x 10/100M adaptive ethernet port, RJ45 connector, with led indicator. It can be used to access the network.

1.3.2 Rear Panel

Introducing the types and definitions of the rear panel interface.

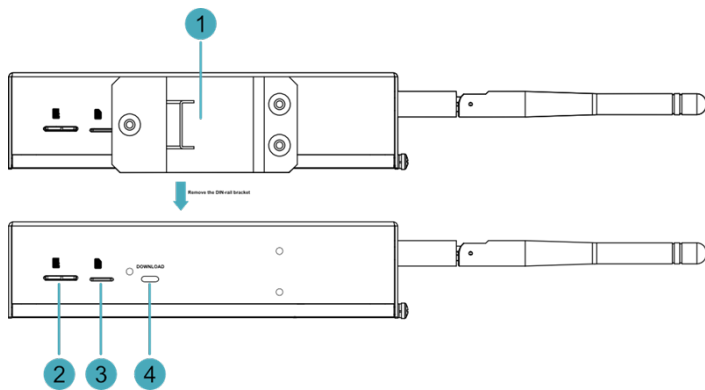

NO.	Function Definition
1	1 x DIN-rail bracket, install ED-IPC2100 Unit on the DIN-rail through the bracket.
2	1 x Micro-SD card slot, it supports the installation of SD card for storing user data.
3	1 x Nano SIM slot, using to install a SIM card for acquiring 4G signals.
4	1 x Micro USB port, it supports to flash to eMMC for the system.

1.3.3 Side Panel

Introducing the types and definitions of side panel interfaces.

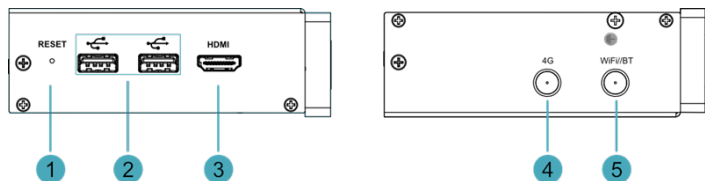

NO.	Function Definition
1	1 x Reset button, hidden button, press the button to restart the device.
2	2 x USB 2.0 ports, type A connector, each channel supports up to 480Mbps.
3	1 x HDMI port, type A connector, which is compatibles with HDMI2.1 standard and supports 4K 60Hz. It supports to connect a displayer.
4	1 x 4G antenna port, SMA connector, which can connect to 4G antenna.
5	1 x Wi-Fi/BT antenna port, SMA connector, which can connect to Wi-Fi/BT antenna.

1.4 Button

ED-IPC2100 series device includes a RESET button, which is a hidden button, and the silkscreen on the case is "RESET". Pressing the RESET button will reset the device.

1.5 Indicator

Introducing the various statuses and meanings of indicators contained in ED-IPC2100 series device.

Indicator	Status	Description
PWR	On	The device has been powered on.
	Blink	Power supply of the device is abnormal, please stop the power supply immediately.
	Off	The device is not powered on.
ACT	Blink	The system started successfully and is reading and writing data.
	Off	The device is not powered on or does not read and write data.
USER	On	User can customize a status according to actual application.
	Off	The device is not powered on or not defined by the user, and the default status is off.
4G	On	The dial-up is successful and the connection is normal.
	Off	4G signal is not connected or the device is not powered on.
Yellow indicator of Ethernet port	On	The data transmission is abnormal.
	Blink	Data is being transmitted over the Ethernet port.
	Off	The Ethernet connection is not set up.
Green indicator of Ethernet port	On	The Ethernet connection is in the normal state.
	Blink	The Ethernet connection is abnormal.
	Off	The Ethernet connection is not set up.
COM1~COM4	On/Blink	Data is being transmitted.
	Off	The device is not powered on or there is no data transmission.

1.6 Interface

Introducing the definition and function of each interface in the product.

1.6.1 Card Slot

ED-IPC2100 series device includes an SD card slot and a Nano SIM card slot.

1.6.1.1 SD Card Slot

The silkscreen on the case of Micro SD card slot is "", which is used to install SD card for storing user data.

1.6.1.2 SIM Card Slot

The silkscreen on the case of Nano SIM card slot is "", which is used to install SIM card for obtaining 4G signals.

1.6.2 Power Supply Interface

The ED-IPC2100 series device includes one power input, 2-Pin 3.5mm spacing phoenix terminals with screw holes. The silkscreen of port is "VIN+/GND", and the pins are defined as follows.

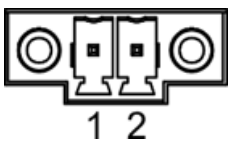
	Pin ID	Pin Name
	1	GND
	2	9V~36V

1.6.3 Audio Interface (optional)

ED-IPC2100 series device includes one audio input, the connector is a 3.5mm four-stage headphone jack. The silkscreen of port is "", which supports OMTP stereo headphone output and mono microphone recording.

- When the headphone is connected, the audio output is switched to the headphone.
- When the headphone is not connected, the audio output is switched to the speaker.

1.6.4 RS485/RS232 Interface

ED-IPC2100 series equipment includes 2~4 RS485 ports and 0~2 RS232 ports, 6-Pin 3.5mm spacing phoenix terminals. Different product models correspond to different numbers of RS485 and RS232 ports:

- ED-IPC2110: 2 x RS485, 2 x RS232
- ED-IPC2120: 2 x RS485, 2 x RS232
- ED-IPC2130: 3 x RS485, 1 x RS232
- ED-IPC2140: 4 x RS485 (not include RS232 port)

Pin Definition

Terminal pins are defined as follows:

	Pin ID	Pin Name
--	--------	----------

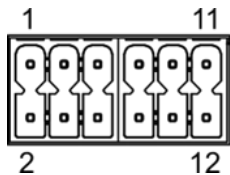

1	RS485-2_B
2	RS485-4_B
3	RS485-2_A
4	RS485-4_A
5	GND
6	GND
7	RS232-1_RX or RS485-1_B
8	RS232-3_RX or RS485-3_B
9	RS232-1_TX or RS485-1_A
10	RS232-3_TX or RS485-3_A
11	GND
12	GND

The pin names of CM4 corresponding to RS485/RS232 interface are as follows:

Signal	CM4 GPIO Name	CM4 Pin Out
RS485-2_B	GPIO13	UART5_RXD
RS485-4_B	GPIO9	UART4_RXD
RS485-2_A	GPIO12	UART5_TXD
RS485-4_A	GPIO8	UART4_TXD
RS232-1_RX or RS485-1_B	GPIO5	UART3_RXD
RS232-3_RX or RS485-3_B	GPIO1	UART2_RXD
RS232-1_TX or RS485-1_A	GPIO4	UART3_TXD
RS232-3_TX or RS485-3_A	GPIO0	UART2_TXD

Connecting Cables

Schematic diagram of RS485 wires is as follows:

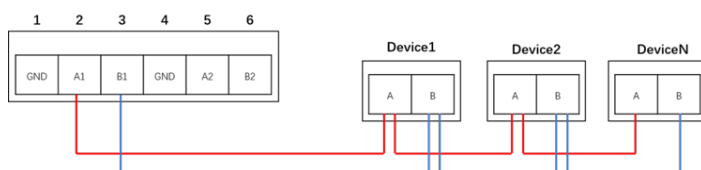

Schematic diagram of RS232 wires is as follows:

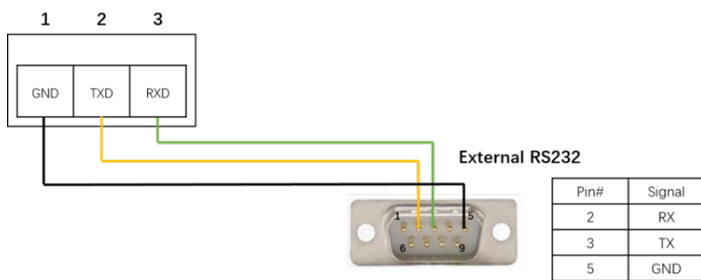

RS485 terminal resistance configuration

If high-frequency signals need to be transmitted by RS485 (baud rate higher than 115200), a terminal resistance of 120Ω needs to be added at the end of the transmission line.

- If the external RS485 device contains a terminal resistance of 120Ω, there is no need to set it.
- If the external RS485 device does not contain the terminal resistance of 120Ω, it is necessary to connect the terminal resistance of 120Ω on ED-IPC2100, as follows:

1. Open the device case, see [2.1.1 Open Device Case](#) for detailed operation.
2. Confirm the positions of 120Ω terminal resistors, such as J19, J21, J24 and J22 in PCBA as shown below.

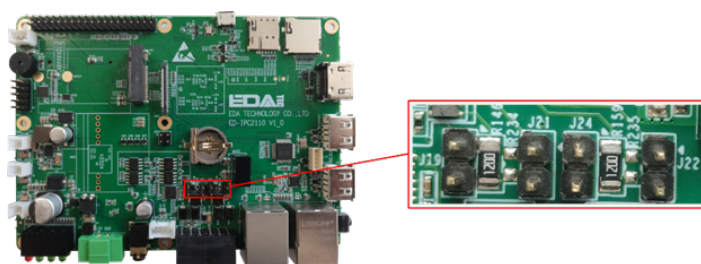

The corresponding relationship between 120Ω terminal resistance and serial port is as follows:

Location in PCBA	Corresponding COM port	The specific location of the corresponding COM
J19	COM3	
J21	COM1	
J24	COM4	
J22	COM2	

1.6.5 1000M Ethernet Interface

ED-IPC2100 series device includes one adaptive 10/100/1000M Ethernet port, and the silkscreen is "1000M". The connector is RJ45, which can support PoE with the expansion module. When accessing to network, it is recommended to use the network cable of Cat6 and above. The pins corresponding to the terminal are defined as follows:

	Pin ID	Pin Name
--	--------	----------

	1	TX1+
	2	TX1-
	3	TX2+
	4	TX2-
	5	TX3+
	6	TX3-
	7	TX4+
	8	TX4-

1.6.6 100M Ethernet Interface

ED-IPC2100 series device includes an adaptive 10/100M Ethernet port, and the silkscreen is

". The connector is RJ45, and it is recommended to use the network cable with Cat6 and above when accessing to network. The pins corresponding to the terminal are defined as follows:

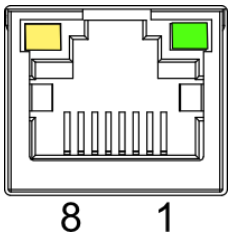
	Pin ID	Pin Name
	1	TX+
	2	TX-
	3	Rx+
	4	-
	5	-
	6	RX-
	7	-
8	-	

1.6.7 HDMI Interface

ED-IPC2100 series device includes one HDMI port, the silkscreen is "HDMI". The connector is type A HDMI, which can connect to an HDMI display and supports up to 4Kp60.

1.6.8 USB 2.0 Interface

ED-IPC2100 series device includes 2 USB 2.0 ports, the silkscreen is "". The connector is type A USB, which can connect to standard USB 2.0 peripherals and supports up to 480Mbps.

1.6.9 Micro USB Interface

ED-IPC2100 series device includes one Micro USB interface, the silkscreen is "DOWNLOAD" and it can be connected to a PC to flash to eMMC of the device.

1.6.10 Antenna Interface

The ED-IPC2100 series device includes 2 SMA antenna ports, the silkscreens are "4G" and "Wi-Fi/BT" and they can be connected to the 4G antenna and Wi-Fi/BT antenna.

1.6.11 Motherboard Interface

Introducing the interfaces reserved in the ED-IPC2100 series device, which can be obtained only after the device case is opened, and can be expanded according to actual needs.

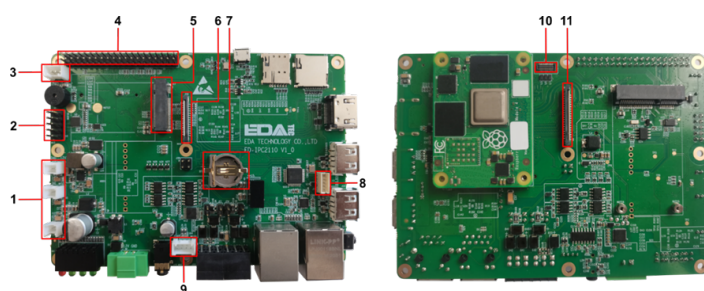

NO.	Function
1	5V 1A Output
2	10-Pin GPIO Pin Header
3	12V 1A Output
4	40-Pin GPIO Pin Header
5	M.2 B Interface
6	FPC DSI Interface Note: Only ED-IPC2120 include this interface
7	RTC Battery Base
8	USB 2.0 Pin Header
9	Speaker Interface Note: Only ED-IPC2120 include this interface
10	CSI Interface Note: Only ED-IPC2120 include this interface
11	FPC HDMI Interface Note: Only ED-IPC2120 include this interface

1.6.11.1 5V 1A Output

The motherboard of ED-IPC2100 series device includes an extended 5V 1A power output port with 3-Pin 2.0mm spacing white WTB connector, which is reserved for the extended LCD screen to supply power. The pins are defined as follows:

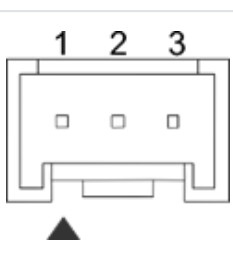
	Pin ID	Pin Name
	1	GND
	2	5V
	3	GND

1.6.11.2 10-Pin GPIO

The motherboard of ED-IPC2100 series device includes a 10-Pin GPIO Pin Header with 2x5-Pin 2.54mm spacing, which is used to lead out the extended GPIO port. The user can customize the extension, and the pins definition are as follows:

	Pin ID	Pin Name
	1	EXIO_P10
	2	3V3
	3	EXIO_P12
	4	EXIO_P11
	5	EXIO_P14
	6	EXIO_P13
	7	EXIO_P16
	8	EXIO_P15
	9	GND
10	EXIO_P17	

1.6.11.3 12V 1A Output

The motherboard of ED-IPC2100 series device includes 3 expanded 12V 1A power output ports with 2-Pin 2.0mm white WTB connector, which is reserved for the extended LCD screen to supply power. The pins are defined as follows:

	Pin ID	Pin Name
	1	GND
	2	12V

1.6.11.4 40-Pin GPIO

The motherboard of ED-IPC2100 series device includes a 40-Pin GPIO terminal with 2x20-Pin 2.54mm spacing, which is used to lead out the GPIO port of CM4, and reserves to connect the extended accessories. The pins are defined as follows:

	Pin ID	Pin Name	Pin ID	Pin Name
	1	3V3_EXT	2	5V2_CM4
	3	GPIO2	4	5V2_CM4
	5	GPIO3	6	GND
	7	GPIO4	8	GPIO14
	9	GND	10	GPIO15
	11	GPIO17	12	GPIO18
	13	GPIO27	14	GND
	15	GPIO22	16	GPIO23
	17	3V3_EXT	18	GPIO24
	19	GPIO10	20	GND
	21	GPIO9	22	GPIO25
	23	GPIO11	24	GPIO8
	25	GND	26	GPIO7
	27	GPIO0	28	GPIO1
	29	GPIO5	30	GND
	31	GPIO6	32	GPIO12
	33	GPIO13	34	GND
	35	GPIO19	36	GPIO16
	37	GPIO26	38	GPIO20
	39	GND	40	GPIO21

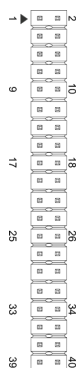

Note:GPIO4~GPIO9, GPIO12, GPIO13 and GPIO22~GPIO27 has been used for other specific functions. If you need to use the function of its ordinary IO, you need to remove the jumper resistance on the corresponding signal line.

1.6.11.5 M.2 B Interface

The motherboard of ED-IPC2100 series device includes a M.2 B Key connector, which is used for external SSD and compatible with M.2 B 2230 and M.2 B 2242 SSD.

1.6.11.6 FPC DSI Interface (optional)

The motherboard of ED-IPC2100 series device includes one extended DSI interface, 30-pin 0.5mm FPC connector and 4-Lane DSI signal. It supports the output of MIPI display signal to LCD screen, reserves to connect the extended LCD screen. It supports USB/I2C touch screen and backlight adjustment, and the pins are defined as follows:

TIP

Only ED-IPC2120 include this interface.

Pin ID	Pin Name	Pin ID	Pin Name
1	GND	2	USB_DM_LCD
3	USB_DP_LCD	4	GND
5	GND	6	SCL_LCD
7	SDA_LCD	8	GND
9	TPINT_L	10	GND
11	GND	12	DSI1_D0_N
13	DSI1_D0_P	14	GND
15	GND	16	DSI1_D1_N
17	DSI1_D1_P	18	GND
19	GND	20	DSI1_CLK_N
21	DSI1_CLK_P	22	GND
23	GND	24	DSI1_D2_N
25	DSI1_D2_P	26	GND
27	GND	28	DSI1_D3_N
29	DSI1_D3_P	30	GND

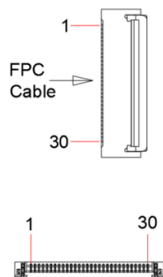

1.6.11.7 RTC Battery Base

The motherboard of ED-IPC2100 series device is integrated with RTC. For the version sold in China, we will install CR1220 battery (RTC backup power supply) by default.



RTC can ensure that the system has an uninterrupted and reliable clock, which is not affected by factors such as the device is power down.

TIP

Some international logistics do not support the transportation of batteries, and some ex-factory devices are not equipped with CR1220 batteries. Therefore, before using RTC, please prepare a CR1220 battery and install it on the motherboard.

1.6.11.8 USB 2.0 Interface

The motherboard of ED-IPC2100 series device includes an extended USB 2.0 Pin Header with 5-Pin 1.5mm spacing WTB connector. It is used to expand a USB 2.0 interface, the pins are defined as follows:

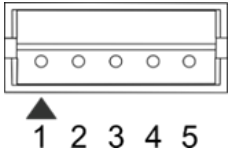
	Pin ID	Pin Name
	1	VBUS
	2	USB_DM
	3	USB_DP
	4	GND
	5	GND

1.6.11.9 Speaker Interface (optional)

The motherboard of ED-IPC2100 series device includes one extended Speaker output with 4-Pin 2.0mm spacing WTB connector. Dual-channel stereo output, which can be extended to connect two 4Ω 3W stereo speakers. The pins are defined as follows:

TIP

Only ED-IPC2120 include this interface.

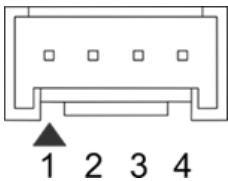
	Pin ID	Pin Name
	1	R+
	2	R-
	3	L+
	4	L-

1.6.11.10 CSI Interface (optional)

The motherboard of ED-IPC2100 series device includes one extended CSI interface, 2x15-Pin 0.4mm spacing connector and 2-Lane CSI signal. It is used to expand the connection of 8-megapixels CSI camera, the pins are defined as follows:

TIP

Only ED-IPC2120 include this interface.

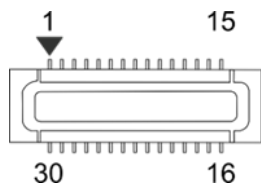

Pin ID	Pin Name	Pin ID	Pin Name
1	NC	2	NC
3	1V8_CM4	4	1V2_CSI
5	1V8_CM4	6	GND
7	CSI_MCLK	8	GND
9	GND	10	2V8_CSI
11	NC	12	NC
13	NC	14	NC
15	GND	16	GND
17	NC	18	NC
19	GND	20	CSI_D1_N
21	CSI_D1_P	22	GND
23	CSI_D0_N	24	CSI_D0_P
25	GND	26	CSI_CLK_N
27	CSI_CLK_P	28	GND
29	SCL_1V8	30	SDA_1V8

1.6.11.11 FPC HDMI Interface (optional)

The motherboard of ED-IPC2100 series device includes one extended HDMI interface with 40-pin 0.5mm spacing FPC connector. It supports video signal output to LCD screen, reserves to connect the extended LCD screen. It supports USB/I2C touch screen and backlight adjustment. The pins are defined as follows:

TIP

Only ED-IPC2120 include this interface.

Pin ID	Pin Name	Pin ID	Pin Name
1	NC	2	NC
3	NC	4	NC
5	NC	6	NC
7	NC	8	GND
9	HDMI1_CLKN	10	HDMI1_CLKP
11	GND	12	GND
13	HDMI1_TX0N	14	HDMI1_TX0P
15	GND	16	GND
17	HDMI1_TX1N	18	HDMI1_TX1P
19	GND	20	GND
21	HDMI1_TX2N	22	HDMI1_TX2P
23	GND	24	GND
25	HDMI1_CEC	26	GND
27	HDMI1_SCL	28	HDMI1_SDA
29	GND	30	HDMI1_HPD
31	GND	32	TPINT_L
33	GND	34	SDA_LCD
35	SCL_LCD	36	GND
37	GND	38	USB_DP_LCD
39	USB_DM_LCD	40	GND

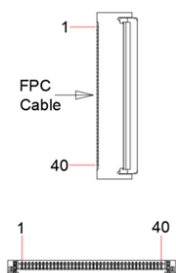

2 Installing Components

This chapter describes how to install optional components.

2.1 Installing Internal Components (optional)

Before installing the internal components, it is necessary to open the device case.

2.1.1 Open Device Case

Preparation:

A cross screwdriver has been prepared.

Steps:

1. Pull out the default configuration of phoenix connector (male for wiring).
2. Use a screwdriver to loosen two M3 screws on two sides counterclockwise, as shown in the red mark in the figure below.



3. Remove the front cover to the right, as shown in the figure below.



4. Use a screwdriver to loosen four M2.5 screws and one grounding screw on two sides counterclockwise, as shown in the red mark in the figure below.



5. Remove the upper cover upward and turn it to the antenna port side, as shown in the figure below.



2.1.2 Install RTC battery

TIP

Some international logistics do not support the transportation of batteries, and some ex-factory devices are not equipped with CR1220 batteries. Therefore, before using RTC, please prepare a CR1220 battery and install it on the motherboard.

Preparation:

- The device case has been opened.
- The CR1220 battery has been prepared.

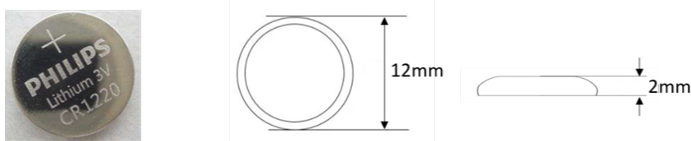

Steps:

1. Locate the RTC battery base where the battery is to be installed, as shown in the red box below.



2. Put the positive pole of the battery upwards and press it into the RTC base. The installation effect is as shown below.



2.1.3 Close Device Case

Preparation:

A cross screwdriver has been prepared.

Steps:

1. Turn the upper cover downwards, align the ports on PCBA with the ports on each side panel and close the upper cover.



2. Align the screw holes on the upper and side panels, and use a screwdriver to tighten four M2.5 screws and one grounding screw on two sides clockwise, as shown in the following figure.



3. Align the ports on PCBA with the ports on the front panel, insert the front cover, and then use a screwdriver to fasten two M3 screws clockwise, as shown in the following figure.



4. Plug in the default configuration of phoenix connector.

2.2 Installing Other Components

If the selected ED-IPC2100 series device includes 4G and Wi-Fi functions, the SIM card and antenna need to be installed before using the device.

2.2.1 Install Antenna (optional)

Preparation:

The corresponding antennas have been obtained from the packaging box. If there are multiple antennas, they can be distinguished by the labels on the antennas.

Steps:

1. Locate the antenna port where the antenna is to be installed, as shown in the red box in the figure below.



2. Align the ports on both sides of the device and the antenna, and tighten them clockwise to ensure that they will not fall off.

2.2.2 Install Micro SD Card

Preparation:

The Micro SD card to be used has been obtained.

Steps:

1. Locate the Micro SD card slot where the Micro SD is to be installed, as shown in the red box below.



2. Insert the Micro SD card with the front face down into the corresponding card slot, and hear a sound to indicate that the installation is complete.



2.2.3 Install Nano SIM Card (optional)

Preparation:

The 4G Nano SIM card to be used has been obtained.

Steps:

1. Use a cross screwdriver to loosen three screws on the DIN-rail bracket counterclockwise (red box position in the figure below) and remove the default DIN-Rail bracket.



2. Locate the Nano SIM card slot where the Nano SIM card is to be installed, as shown in the red box below.



3. Insert the Nano SIM card into the corresponding card slot with the chip side up, and hear a sound to indicate that the installation is complete.



4. Install the DIN-Rail bracket onto the device case.

3 Installing Device

This chapter introduces how to install the device.

3.1 DIN-Rail Installation

When the ED-IPC2100 series device leaves the factory, the DIN-rail bracket is installed as standard by default.

Steps:

1. Face the side of the DIN-rail bracket to the rail to be installed, and the upper side of the bracket is sleeved on the upper side of the rail.

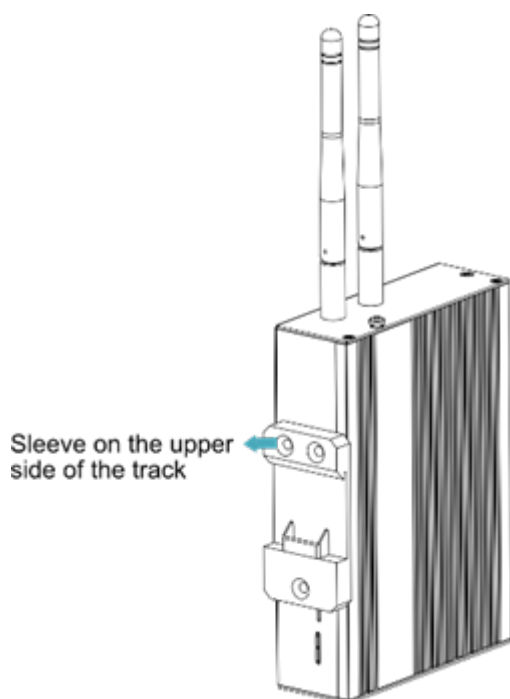

2. Press down the buckle on the lower side of the DIN-rail bracket until the bracket can be buckled on the rail, and the installation is completed.

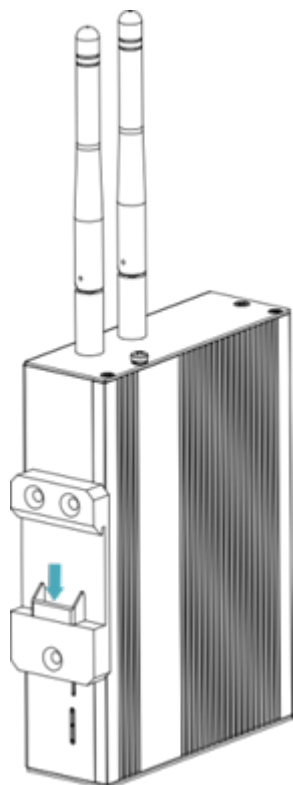

4 Booting the Device

This chapter introduces how to connect cables and boot the device.

4.1 Connecting Cables

This section describes how to connect cables.

Preparation:

- Accessories such as display, mouse, keyboard and power adapter that can be used normally have been ready.
- A network that can be used normally.
- Get the HDMI cable and network cable that can be used normally.

Schematic diagram of connecting cables:

Please refer to [1.6 Interfaces](#) for the pin definition of each interface and the specific method of wiring.

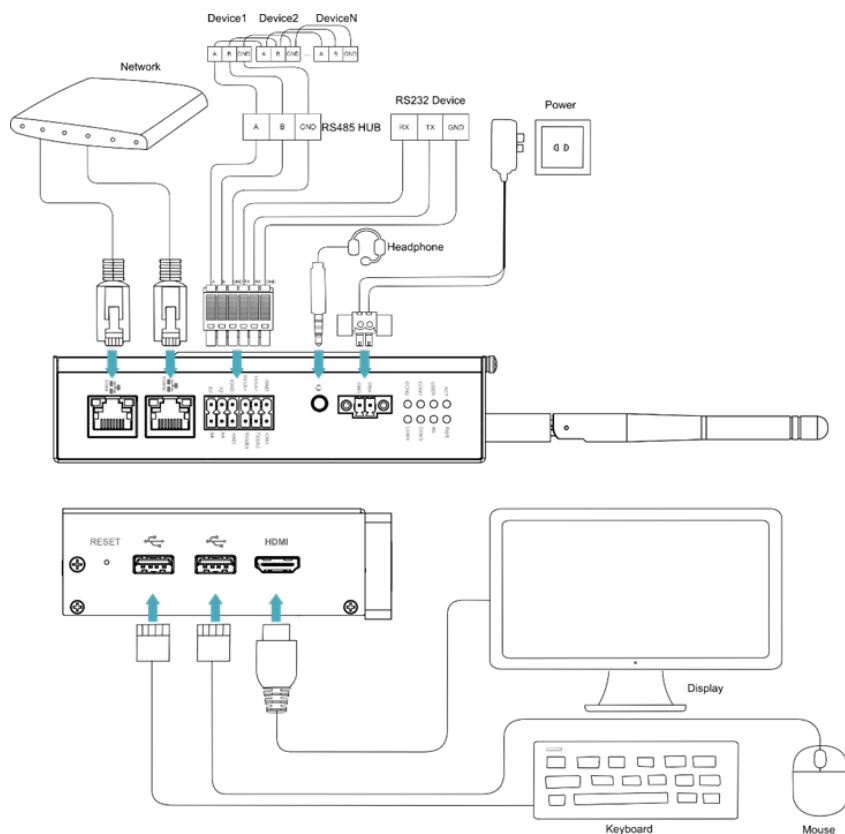

4.2 Booting The System For The First Time

ED-IPC2100 series device has no switching power supply. After the power supply is connected, the system will start.

- The red PWR indicator is on, indicating that the device has been powered normally.

- The green ACT indicator is blinking, indicating that the system is started normally, and then the logo of Raspberry Pi will appear in the upper left corner of the screen.

TIP

Default username is `pi` , Default password is `raspberrypi` .

4.2.1 Raspberry Pi OS (Desktop)

If the Desktop version of the system is installed when the product leaves the factory, after the device is started, it will directly enter the desktop, as shown in the following figure.

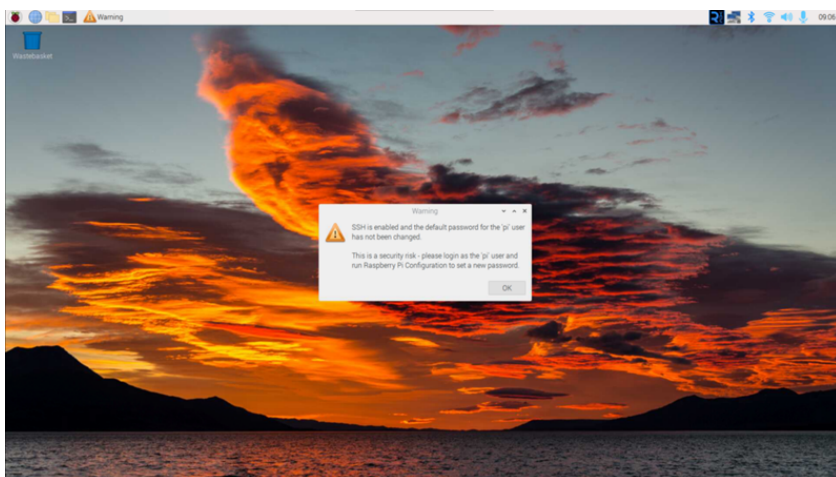

4.2.2 Raspberry Pi OS (Lite)

If the Lite version of the system is installed at the factory, the default username pi will be used to automatically log in after the device is started, and the default password is raspberrypi. The following figure shows that the system has been started normally.

```
[ OK ] Started LSB: rng-tools (Debian variant).
[ OK ] Started WPA supplicant.
[ OK ] Started Authorization Manager.
[ OK ] Reached target Network.
[ OK ] Listening on Load/Save RF #itch Status /dev/rfkill Watch.
Starting Modem Manager...
Starting /etc/rc.local Compatibility...
Starting Permit User Sessions...
[ OK ] Finished Remove Stale OnlimeX4 Metadata Check Snapshots.
[ OK ] Started /etc/rc.local Compatibility.
Starting Load/Save RF Kill Switch Status...
[ OK ] Finished Permit User Sessions.
[ OK ] Started Getty on tty1.
[ OK ] Reached target Login Prompts.
[ OK ] Started Load/Save RF Kill Switch Status.
[ OK ] Started User Login Management.
Starting Save/Restore Sound Card State...
[ OK ] Finished Save/Restore Sound Card State.
[ OK ] Reached target Sound Card.
[ OK ] Started Modem Manager.
[ OK ] Started LSB: Switch to ondt(unless shift key is pressed).

Raspbian GNU/Linux 11 raspberrypi tty1
raspberrypi login: pi
Password:
Linux raspberrypi 6.1.21-08+ #1642 SMP PREEMPT Mon Apr 3 17:24:16 BST 2023 aarch64

The programs included with the Debian GNU/Linux system are free software;
the exact distribution terms for each program are described in the
individual files in /usr/share/doc/*/copyright.

Debian GNU/Linux comes with ABSOLUTELY NO WARRANTY, to the extent
permitted by applicable law.
Last login: Tue Jul 11 11:15:28 BST 2023 on tty1

Wi-Fi is currently blocked by rfkill.
Use raspi-config to set the country before use.

pi@raspberrypi:~$
```

5 Configuring System

This chapter introduces how to configure system.

5.1 Finding Device IP

Finding Device IP

5.2 Remote Login

Remote Login

5.3 Configuring Storage Devices

Configuring Storage Devices

5.4 Configuring Ethernet IP

Configuring Ethernet IP

5.5 Configuring Wi-Fi (Optional)

Configuring Wi-Fi

5.6 Configuring Bluetooth (Optional)

Configuring Bluetooth

5.7 Configuring 4G (Optional)

Configuring 4G

5.8 Configuring Buzzer

Configuring Buzzer

5.9 Configuring RTC

Configuring RTC

5.10 Configuring Serial Port

This chapter introduces the configuration method of RS232 and RS485.

5.10.1 Installing picocom tool

In the Linux environment, you can use the picocom tool to debug the serial ports RS232 and RS485.

Execute the following command to install the picocom tool.

```
sudo apt-get install picocom
```

sh

5.10.2 Configuring RS232

ED-IPC2100 includes 0~2 RS232 ports with their corresponding COM ports and device files, as shown in the table below:

ED-IPC2110 and ED-IPC2120

Number of RS232 Ports	Corresponding COM Port	Corresponding Device File
2	COM1, COM3	/dev/com1, /dev/com3

ED-IPC2130

Number of RS232 Ports	Corresponding COM Port	Corresponding Device File
1	COM1	/dev/com1

Preparation:

The RS232 port of ED-IPC2100 has been connected with external device.

Steps:

1. Execute the following command to open the serial port com1, and configure the serial port baud rate to 115200.

```
picocom -b 115200 /dev/com1
```

sh

2. Input commands as needed to control external device.

5.10.3 Configuring RS485

ED-IPC2100 includes 2~4 RS485 ports with their corresponding COM ports and device files, as shown in the table below:

ED-IPC2110 and IPC2120

Number of RS485 Ports	Corresponding COM Port	Corresponding Device File
2	COM2, COM4	/dev/com2, /dev/com4

ED-IPC2130

Number of RS485 Ports	Corresponding COM Port	Corresponding Device File
3	COM2, COM3, COM4	/dev/com2, /dev/com3, /dev/com4

ED-IPC2140

Number of RS485 Ports	Corresponding COM Port	Corresponding Device File
4	COM1, COM2, COM3, COM4	/dev/com1, /dev/com2, /dev/com3, /dev/com4

Preparation:

The RS485 port of ED-IPC2100 has been connected with external devices.

Steps:

1. Execute the following command to open the serial port com4, and configure the serial port baud rate to 115200.

```
picocom -b 115200 /dev/com4
```

sh

2. Input commands as needed to control external devices.

5.11 Configuring Audio (Optional)

Configuring Audio

5.12 Configuring USER Indicator

Configuring USER Indicator