



ED-HMI2002-070C

DataSheet

by EDA Technology Co., Ltd

built: 2024-10-18

ED-HMI2002-070C

7.0-inch Industrial HMI Based on Raspberry Pi 4

- 7.0" TFT, resolution 1024x600, multi-point capacitive touch screen
- Broadcom BCM2711, quad-core Arm Cortex-A72 (ARM v8) 64-bit SoC @ 1.5GHz
- Up to 8GB LPDDR4 RAM, 32GB or 64GB SD Card storage
- 1 x Gigabit ethernet port, 2 x USB 3.0, 2 x USB 2.0
- Dual 4Kp60 HDMI display output
- 5V DC power input via USB-C
- 8-megapixel front camera is optional
- Aluminum CNC + sheet metal case, fanless design, providing excellent cooling performance
- Embedded installation, compatible with VESA standard bracket installation



Specifications

System	
CPU	Broadcom BCM2711, quad core Arm Cortex-A72 (ARM v8) 64-bit SoC@1.5GHz
VPU	H.265 (HEVC), up to 4Kp60 decode H.264, up to 1080p60 decode, 1080p30 encode
GPU	OpenGL ES 3.1 & Vulkan 1.0
Memory	Options for 1GB, 2GB, 4GB, 8GB LPDDR4-3200 SDRAM
Storage	32GB and 64GB SD Storage Card are optional

software	
Operating System	Raspberry Pi OS (Desktop) 32-bit Raspberry Pi OS (Lite) 32-bit Raspberry Pi OS (Desktop) 64-bit Raspberry Pi OS (Lite) 64-bit

Front I/O	
Camera	Built-in 8-megapixel front camera (optional).

Side I/O	
USB 2.0	2 x USB 2.0 ports, dual layer type A connector, each channel supports up to 480Mbps.

Side I/O	
USB 3.0	2 x USB 3.0 ports, dual layer type A connector, each channel supports up to 5Gbps.
1000M Ethernet	1 x adaptive 10/100/1000M ethernet port, RJ45 connector. It can be used to access the network.
SD Card Slot	1 x Micro SD card slot, which is used to install SD card. It supports booting the OS from SD card.
Audio	1 x Audio port, 3.5mm audio jack connector, 4-pole stereo audio.
HDMI	2 x HDMI ports, Micro HDMI connector, supporting 4K 60Hz.
Power	1 x power in port, USB Type-C connector, supporting 5V/3A DC power input.

Internal I/O	
PoE	1 x PoE port, reserving to connect PoE module.

LCD	
LCD Size	7.0" TFT
Resolution	1024 x 600
Colors	16.7MB
Active Area	154.21mm (H) x 85.92mm (V)
Backlight	LED
MTBF	>30000h
Luminance	400cd/m ²
Contrast Ratio	800:1
Response Time	30ms
Viewing Angle (CR≥10)	85° (L) / 85° (R) / 85° (U) / 85° (D)

Touch Screen	
Type	Multi-point Capacitive Touch Screen
Transmittance	≥85%
ConnectionMethod	COF
ControllerInterface	I2C
Driver Support	Linux
Multi-touch	10 points
SurfaceHardness	6H

Electrical Characteristics	
Input Voltage	5V DC
Power Consumption	15W (Max)

Mechanical Characteristics	
Dimensions	188mm x 123mm x 39.5mm (WxDxH)
Weight	About 800g
Installation	Embedded front installation

Wireless	
Wi-Fi	Dual-band 802.11ac Wi-Fi
Bluetooth	Bluetooth 5.0 / Bluetooth Low Energy (BLE)

Environmental & Regulatory	
Operating Temperature	-25°C ~ 60°C
Storage Temperature	-25°C ~ 60°C
Ambient humidity	5% ~ 95% (non-condensing)
Certifications	FCC FCC 47 CFR Part 15 Subpart B CE EN IEC 62368-1/EN IEC 62311/EN IEC 61000-3-2/EN IEC 61000-3-3 EN 55032/EN 55035 EN 301 489-1/EN 301 489-3/EN 301 489-17/EN 301 489-52 EN 301 328/EN 301 440/EN 301 511/EN 301 908-1/EN 301 908-2

System Diagram

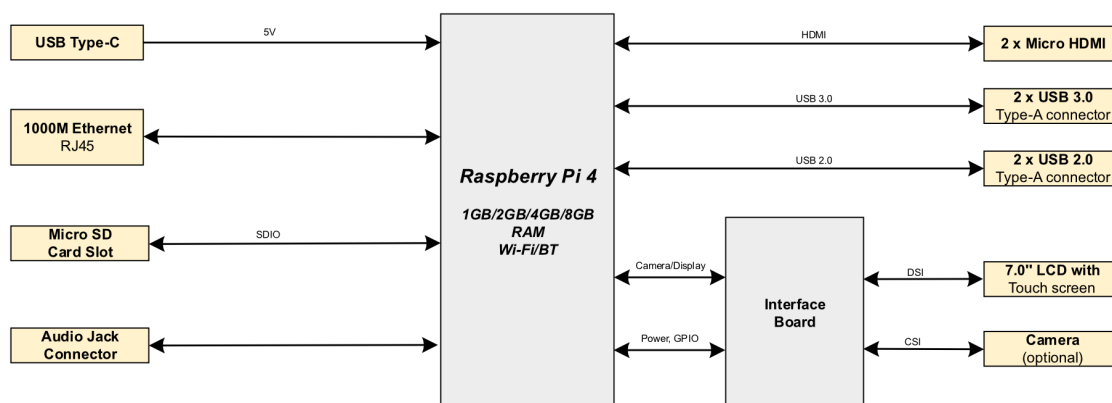

Dimensions

Unit: mm

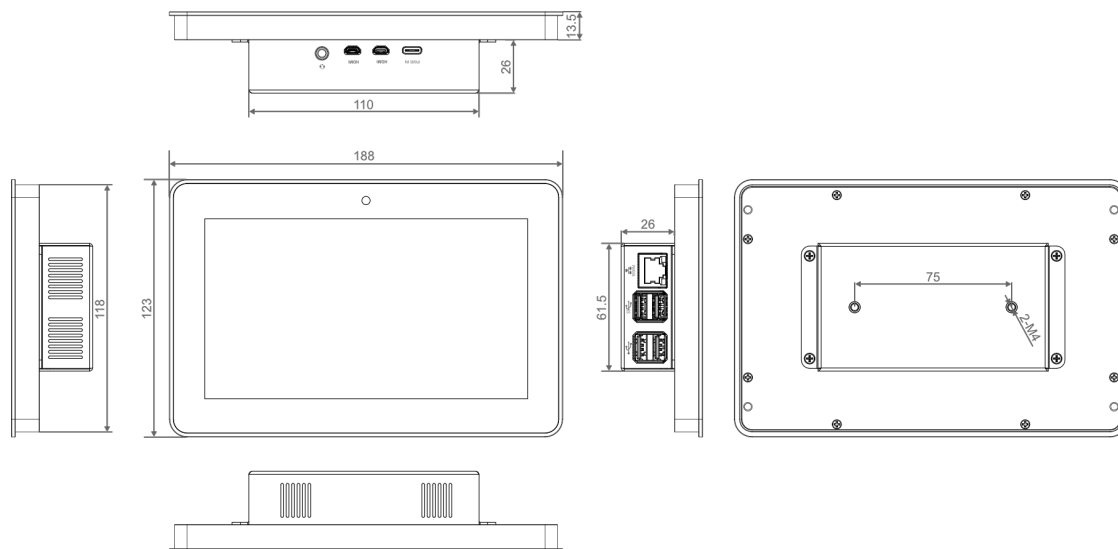

Ordering Code

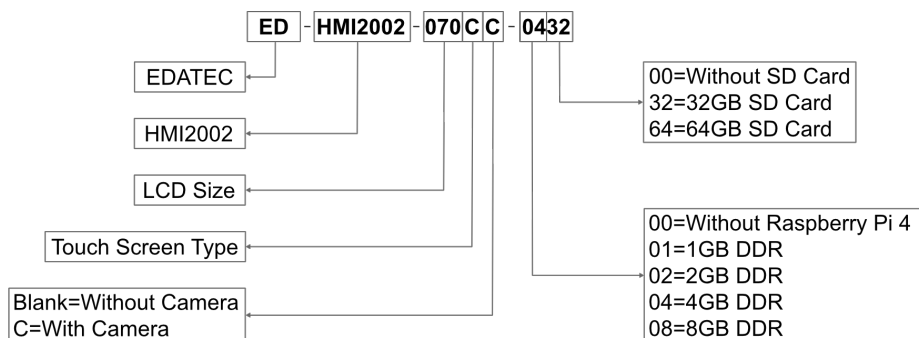

Example

P/N: **ED-HMI2002-070CC-0432**

Configuration: 7.0-inch Industrial HMI Based on Raspberry Pi 4, with 4GB DDR, Camera and 32GB SD card.

Special Model Description:

Model	Description
ED-HMI2002-070C-0000	7.0-inch LCD Touch Screen for Raspberry Pi 4, with metal case.
ED-HMI2002-070CC-0032	7.0-inch LCD Touch Screen for Raspberry Pi 4, with metal case, camera and 32GB SD card.

Optional Accessory

You can also choose HMI Mounting Kit for embedded front installation according to actual needs.

Model	Description	Picture
ED-ACCHMI-Front	HMI Mounting Kit for Front Installation, with 4 x buckles, 4 x M4*10 screws and 4 x M4*16 screws.	

You can choose a Raspberry Pi Power Adapter according to actual needs.

Model	Description	Picture
SC0219	Raspberry Pi 15W USB-C Power Supply Black AU	
SC0523	Raspberry Pi 15W USB-C Power Supply White AU	
SC1412	Raspberry Pi 15W USB-C Power Supply Black EU	
SC0753	Raspberry Pi 15W USB-C Power Supply White EU	
SC0479	Raspberry Pi 15W USB-C Power Supply Black IN	
SC0478	Raspberry Pi 15W USB-C Power Supply White IN	
SC0216	Raspberry Pi 15W USB-C Power Supply Black UK	
SC0443	Raspberry Pi 15W USB-C Power Supply White UK	
SC0218	Raspberry Pi 15W USB-C Power Supply Black US	
SC0445	Raspberry Pi 15W USB-C Power Supply White US	

Packing List

- 1 x ED-HMI2002-070C Unit